

ಹುಬ್ಬಳ್ಳಿ ಧಾರವಾಡ
HUBBALLI DHARWAD



ಸ್ಮಾರ್ಟ್ ಸಿಟಿ ಅಮಿಟೆಡ್
SMART CITY LIMITED



Special Purpose Vehicle for Implementation of Smart City Project
(Registered Company No. CIN : U74999KA2017 PLC 101265)

No:HDSCL/DSCQUOTATION/MD/2023-24

Date:06.11.2023

Quotation Notification

Advt.No.07/2023-24/01Date:06.11.2023

1. The Managing Director, Hubballi-Dharwad Smart City Ltd (HDSCL) invites the Quotation on behalf of Hubballi-Dharwad Smart City (HDSCL) For “Implementation of Digital Smart Class and School Automation” under Hubballi Dharwad Smart city limited.
2. The bidders have to provide Quotation rates only in the name of Managing Director Hubballi Dharwad Smartcity Limited.
3. For further details please contact General Manager (Tech.), Hubballi-Dharwad Smart City Limited, Hubballi during the Office hours onTelephoneNo:083-2355331and 2355322,

Name of Work : Implementation of Digital Smart Class and School Automation in Hubballi		
Sl. No	Item	Unit
1	All in one computer desktop AIO Desktop Intel Core i5- 13th generation or higher 4 Cores or higher, 8 GB DDR4 or DDR5 Expendable to 32 GB HDD 1 TB, 3.00 USP Port 3 Numbers and 2.00 USB Port 3 No, wifi inbuilt with Speaker inbuilt, Wired Keyboard & Mouse, WIFI 6 + BT 5.1, 21.5" Monitor 21.5 inch FHD Monitor P2222H Featuring Comfortview Plus Technology, Security-Lock Slot, HDMI Port, DisplayPort, VGA Connector, Stand Lock, Height Adjustment 150mm. Display Resolution Maximum 1920 x 1080, Special Feature Flicker Free, Refresh Rate 60 Hz, Win 11 Professional+ MS Office 2021 + Adobe + Antivirus 3.00 USB 3 Port , 2.00 USB 3 port Featuring PCIe 5.0 and 4.0 support, DDR5 and DDR4 support.	No
2	Running computer table – per sitting size: 27"x18"x12"x48"(h). Top 18mm, 2mm edge finish. Material: Pre-laminated particle board.	No
3	Computer Lab (CL) - replace ubuntu by Windwows 11/10 where the PCs have Ubuntu in computer lab.	No
4	Wi-Fi Dongle with Internet recharge. Wi-Fi transmission protocol: 802.11, transmission rate up-to 40mbpps. Built-in battery with charging option.	No
5	Computer Lab Setup (20 Students) 260W Win 11 Home + MS Office 2021) including Floor Mat, Screen, Painting, Electrical Work, Table, Chair. Running computer table – per sitting size: 27"x18"x12"x48" (h). Top 18mm, 2mm edge finish. Material: Pre-laminated particle board. Chairs: Electrical work: 4 modal box, 3 3-pin sockets, 1 switch and required cables.Floor mat: Polyvinyl chloride 1.5mm including SR paste. Curtain-Vertical blinds screen with frills on and off with aluminum framing. AIO Desktop Intel Core i5- 13th generation or higher 4 Cores or higher, 8 GB DDR4 or DDR5 Expendable to 32 GB HDD 1 TB, 3.00 USP Port 3 Numbers and 2.00 USB Port 3 No, wifi inbuilt with Speaker inbuilt, Wired Keyboard & Mouse, WIFI 6 + BT 5.1, 21.5' Monitor 21.5 inch FHD Monitor P2222H Featuring Comfortview Plus Technology, Security-Lock Slot, HDMI Port, DisplayPort, VGA Connector, Stand Lock, Height Adjustment 150mm. Display Resolution Maximum 1920 x 1080, Special Feature Flicker Free, Refresh Rate 60 Hz, Win 11 Professional+ MS Office 2021 + Adobe + Antivirus 3.00 USB 3 Port, 2.00 USB 3 port Featuring PCIe 5.0 and 4.0 support, DDR5 and DDR4 support.	Set
6	Computer Lab Software's 1: Digital Library Advanced digital version of collection, organization, access and presentation of books. The categories included are mainly based on different subject domains. Also categorized	Set

ಸಿಎಸ್‌ಎಸ್ ನಂ. 122/124, ಎಚ್‌ಡಿಎಮ್‌ಸಿ ಸಾಂಸ್ಕೃತಿಕ ಭವನ, 1ನೇ ಮಹಡಿ, ನ್ಯೂ ಕಾಟನ್ ಮಾರ್ಕೆಟ್ ರಸ್ತೆ, ಹುಬ್ಬಳ್ಳಿ-580029

CSS No. 122/124, HDMC Samskrutika Bhavan, 1st Floor, New Cotton Market Road, Hubballi-580029

Ph: 0836-2355322, Fax: 0836-2355331, Control Room Assistance: 2213888/2213898,

Website: www.hubballidharwadsmartcity.com E-mail: smartcityhubballidharwad@gmail.com

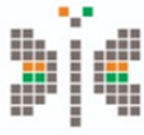

Special Purpose Vehicle for Implementation of Smart City Project
(Registered Company No. CIN : U74999KA2017 PLC 101265)

	based the standard syllabus, e News papers, NCRT books.	
7	Computer Lab Software's 2: English Language Lab with Head Phone with Mic Content: Listening, speaking, reading, writing, phonetics, vocabulary builder, soft-skill and life-skills etc. Three levels available – basic, intermediate and mastery	Set
8	Science Lab (Composite) Furniture Setup (Physics +Chemistry Biology) Detailed in Annexure B	Set
9	Science Lab Equipment's Detailed in Annexure C	Set
10	E-Learning State Board Kannada Medium Content Software (1-10th std) E-learning 2D/3D multi-media offline content, Karnataka State Board Kannada/Urdu/English medium with all 6 subjects having updated content. Software Content should be in line with Department of State Educational Research and Training (DSERT) in Kannada/Urdu/English with all 6 subjects having updated content.	No
11	Smart Class Setup All in one Smart Interactive Multi Touch Flat Panel 75" inch. 4k Resolutions, 20Touch Point for Writing, Anti- Glare Toughened Tempered Glass with Smooth Writing Surface, Wide Viewing Angle Feature. Android: Android 11 and Above 3GB/32GB Win OPS (System): Intel Core i5/8GB/1TB HDD/128GB SSD/Win 11. Professional, HDMI Support USB Support 2.00 and 3.00 With All types of educational apps. Access. Speaker: 15x2 Watts – 30Watts Speakers.	No
12	CCTV: 16 Channel DVR, Camera with Accessories and Installation16 channel SMPS, 2 TB hard disk, 4"x4" box, BNC and DC connectors, 3+1 cable, 4U rack, spike buster, casing/piping. CCTV Cameras with NVR 4 Mega Pixel or higher, IP Bullet Camer Night Vision, Dust free , Weather Free, Indoor and outdoor 180 degree or Fix camera.	Set
13	7.5 KVA Solar UPS Inverter + Battery+ Panel-Fabrication and Accessories SVPRO 7.5 KVA+100 ah-8Nos+panel 550 w x 8 NosItem Specifications Capacity As per the requirement of the proposed device (Preferably not less than 1KVA or as required with 1 hr backup),Backup Min 1 hour,Input voltage range 160v – 300v AC Single phase Input Frequency range 50 Hz +/- 5%,Output voltage 220VAC/230VAC +/- 1% Output frequency 50 Hz +/- 0.05 Hz (Free Running),Indicators (Display) LCD Display for fault/status information,Battery & Load level indicator Online , On battery , Replace Battery, Battery Type Sealed Maintenance Free Tubular Batteries Battery Recharge time from fully discharge condition to 100% <= 5 hours Battery Housing Rack/Cabinet,Input Transformer Inbuilt galvanic isolation transformer at input.	No
14	UPS Stand	No
15	MS Grill Door for Computer Lab Dimension: 7ft x 3ft Gauge: 14 With 2 coats of enamel paint over a coat of primer.	No
16	Mathematics Lab Detailed in Annexure D	Set
17	Installation, Delivery and Training Charges	Lumsum

Sd/-
General Manager (Tech)
Hubballi-Dharwad Smart City Limited.,
Hubballi

Sd/-
Managing Director
Hubballi-Dharwad Smart City Limited.,
Hubballi



Special Purpose Vehicle for Implementation of Smart City Project
(Registered Company No. CIN : U74999KA2017 PLC 101265)

Annexure B: Plans and Detailed Specification of Computer Lab

Computer Lab per Table Plan (Example)

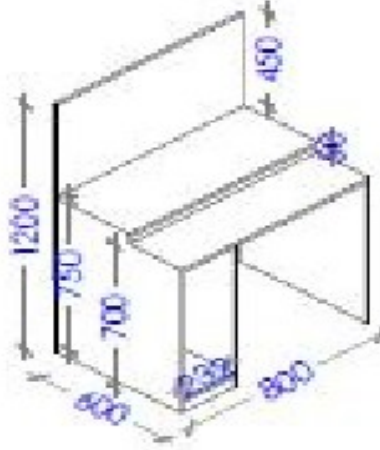

Science Lab Furniture Plan for Example

COMPOSITE LAB

7600 (Total Length)
450 (Table Width)
2100 (Table Length)
1200 (Table Spacing)
1600 (Table Spacing)
1500 (Table Spacing)
1800 (Table Spacing)
1800 (Table Spacing)
800 (Table Height)
650 (Table Depth)

A) CHEMISTRY TABLE : 1 No

4200x1200x900mm(ht)

B) PHYSICS & C) BIOLOGY TABLE

4200x1200x900mm(ht)

SINK TABLE : 1 No

850x850x900mm(ht)

STORAGE CUPBOARD : 1 No

900x450x1950mm(ht)

Rev/No	For/Remarks	Date
1	Drawing has modified	25/02/22



Annexure C: Science Lab specification

Science Lab Equipment's List for Example

S.No	Item Description
01	Chemistry Lab. Table Dimension : 4200 x 1200 x 900mm. Material of Construction : Made of 20G thick GI Tata Sheet. Under Bench Cupboard: Under Bench Cupboards will be provided Two Shutter with One Horizontal Partition. Finish: Interior and Exterior will be provided with 70 to 80 microns Epoxy Powder Coated Finish. Table Top: 18 ± 1 mm thick well-polished Black Granite with half round nosing. Modular Laying: Alternative with Knee holes. Reagent Rack: 02 Nos. of Reagent Rack will be provided
02	Physics / Biology Lab Table Dimension : 4200 x 1200 x 900mm. Material of Construction : Made of 20G thick GI Tata Sheet. Finish: Interior and Exterior will be provided with Powder Coated Finish. Under Bench Cupboard: Under Bench Cupboards will be provided Two Shutter with One Horizontal Partition. Table Top: 18 ± 1 mm thick well-polished Black Granite with half round nosing Amenities: 08 Nos.of Electrical Point will be Provided.
03	Sink Unit Dimension : 850 x 700 x 900mm. Material of Construction: Made of 20G thick GI Tata Sheet. Sink & Tap – 01 No. PP Sink Dimension: 560 x 355 x 245 mm (LxBxH) Material of Construction: Made from Highly Chemical Resistant PP Materials with Superior surface finish & Block color. Tap: Three-way Goose Neck water Taps -01 Nos. Material of Construction: Made from High quality Brass forging grade as per IS8737.Tap is Epoxy Powder coated finish. Tested in Pneumatic Test at 250 Psi in Hydraulic tests at 125 Psi and Bursting test at 500 Psi to avoid Leakage. Goose neck 360 deg Swing.abd Water Static Pressure Max 14 bar
04	Full Height Storage Cupboard:Dimension: 900 x 450 x 1900mm.

Sl.	Item Description with LKU (Labkafe Unit) Number		Qty
Physics			
1	LKPH 073/1 AC	PH 073/1 DYNAMO MODEL AC Superior Quality	1
2	LKPH 076/B	PH 076/B ELECTRIC MOTOR MODEL IN ACRYLIC BODY.	1
3	LKEI 099/1	EI 099/1 CONNECTING LEADS (Spare Leads for Equipment's) Banana to Banana (Non Stackable) Red & Black color (One each)	2
4	LKPH 092/4	PH 092/4 GOLD LEAF ELECTROSCOPE Metallic Frame (Export Quality).	1
5	LKPH 117A	PH 117A KALEIDOSCOPE	1
6	LKPH 170A	PH 170A PERISCOPE	2
7	LKEI 002/2	EI 002/2 BATTERY ELIMINATORS (Superior Quality) DC 2-12V DC 2Amp	4
8	LKPH 002/3 1	PH 002/3 AMMETER (EDM-80) SQUARE Dial Moving Coil DC with Desk Stand Range 0-1Amp.	4
9	LKPH 009/2	PH 009/2 BAR MAGNET Alnico Make (Superior Quality) 50x11x7mm (2")	2
10	LKPH 028/B	PH 028/B ARCHIMEDES EXPERIMENTAL SETUP.	1
11	LKPH 037/A	PH 037/A COMPASS MAGNETIC Dia 18mm Both Side Glass (B.S.G).	6
12	LKPH 043	PH 043 CONSTANTAN WIRE / RESISTANCE WIRE	1

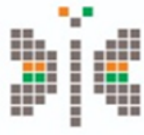

Special Purpose Vehicle for Implementation of Smart City Project
(Registered Company No. CIN : U74999KA2017 PLC 101265)

		(100gm).	
13	LKPH 044/B 15	PH 044/B LENS (EXACT FOCAL LENGTH) DIA 2" FL 15cm Concave Lens (Exact)	5
14	LKPH 045/B 15	PH 045/B LENS (EXACT FOCAL LENGTH) DIA 2" FL 15cm Convex Lens (Exact)	5
15	LKPH 046/1 25	PH 046/1 CONVEX MIRROR F.L.25cm Dia 50mm	5
16	LKPH 047/1 25	PH 047/1 CONCAVE MIRROR F.L.25cm Dia 50mm	5
17	LKPH 053/2	PH 053/2 COPPER WIRE (DCC Wire) Double Cotton Covered for connections 500gm.	1
18	LKPH 072/1	PH 072/1 DRAWING BOARD (Superior Quality Soft Wood) 12"x18".	4
19	LKPH 085/2	PH 085/2 GEOMETRICAL INSTRUMENTS BOX Plastic Superior Quality.	1
20	LKPH 087/2	PH 087/2 GLASS PRISM; Equilateral 60x60x60°, 50mm (Superior Quality)	5
21	LKPH 089/2	PH 089/2 GLASS SLAB (English Glass) 75x50x18 mm.	5
22	LKPH 099/2	PH 099/2 HORSE SHOE MAGNET / 'U' MAGNET (Alnico) 75mm (Superior Quality).	2
23	LKPH 126	PH 126 LENS HOLDER Wooden 'V' Shaped	2
24	LKPH 134/3 B	PH 134/3 (B) MAGNIFIER Plastic Frame (Sup.) Black Colour 3".	1
25	LKPH 144	PH 144 METAL BLOCK RECTANGULAR 4x3x2cm (Aluminium).	2
26	LKPH 145/2	PH 145/2 METER SCALE ONE-meter Superior Quality (Wooden).	2
27	LKPH 145/4	PH 145/4 METER SCALE Half meter Superior Quality (Wooden).	4
28	LKPH 149/B	PH 149/B Mirror Strip Mounted on Wooden Base 4"x2".	3
29	LKPH 151/3	PH 151/3 MULTIMETER Digital (Imported) Superior Quality.	1
30	LKPH 162/E	PH 162/E OPTICAL Bench (Wooden) with Metal Riders.	1
31	LKPH 164/1	PH 164/1 OVER FLOW VESSEL Plastic	1
32	LKPH 176/2	PH 176/2 PLUG KEY, One Way with ½" brass block, Superior Quality	3
33	LKPH 195/10	PH 195/10 RESISTANCE BOX (Brass) Plug Type; Constantan Coil 1/2" Brass Block Teak Wood Case (Deluxe Quality) 1 to 1000 Ohm.	1
34	LKPH 195/9	PH 195/9 RESISTANCE BOX (Brass) Plug Type; Constantan Coil 1/2" Brass Block Teak Wood Case (Deluxe Quality) 1 to 500 Ohm.	1
35	LKPH 197/1	PH 197/1 RESISTANCE COIL Round Bakelite Case. (Range 1 Ohms)	2
36	LKPH 197/1	PH 197/1 RESISTANCE COIL Round Bakelite Case. (Range 10 Ohms)	2
37	LKPH 197/1	PH 197/1 RESISTANCE COIL Round Bakelite Case. (Range 20 Ohms)	2
38	LKPH A201/9 15	PH A201/9 Rheostat (Brass Rod) 4.3cm Dia tube Length 15cms 50 Ohms 1.6 Amps	3
39	LKPH 224/1	PH 224/1 SLINKY SPRING 75x50mm.	2
40	LKPH 238/2 250	PH 238/2 SPRING BALANCE Tubular Acrylic 250gm	2
41	LKPH 247/3	PH 247/3 STOP WATCH Digital 1/100 Sec Racer Make.	3
42	LKPH 265/3 10	PH 265/3 VOLTMETER (EDM-80) SQUARE Dial DC Range 10 Volt	4
43	LKPHN 121/3	PHN 121/3 WHITE SCREEN Wooden.	2

ಸಿಎಸ್‌ಎಸ್ ನಂ. 122/124, ಎಚ್‌ಡಿಎಮ್‌ಸಿ ಸಾಂಸ್ಕೃತಿಕ ಭವನ, 1ನೇ ಮಹಡಿ, ನ್ಯೂ ಕಾಟನ್ ಮಾರ್ಕೆಟ್ ರಸ್ತೆ, ಹುಬ್ಬಳ್ಳಿ-580029

CSS No. 122/124, HDMC Samskrutika Bhavan, 1st Floor, New Cotton Market Road, Hubballi-580029

Ph: 0836-2355322, Fax: 0836-2355331, Control Room Assistance: 2213888/2213898,

Website: www.hubballidharwadsmartcity.com E-mail: smartcityhubballidharwad@gmail.com



Special Purpose Vehicle for Implementation of Smart City Project
(Registered Company No. CIN : U74999KA2017 PLC 101265)

44	LKPHN 65	PHN 65 IRON FILLING 500gm.	1
45	LKPHN 98/2	PHN 98/2 REFLECTION OF SOUND APPARATUS Big Size.	1
46	LK11111	Polylab 11111 Beaker (Euro Design) 50 ml	1
47	LKWC	Wire Cutter.	1
48	LKPH 162/LB	LIGHT BOX with holder and Bulb (Wooden).	1
49	LKAC	Alarm Clock (Small).	1
50	LKBP	Board Pin Packet.	1
51	LKPP	Paper Pin Packet.	1
52	LKCT	COTTON THREAD (Roll).	2
53	LKSP	Sand Paper.	2
54	LKCPH012	CPH012 Educational Raxine Charts (Size 75x100cm); PHYSICS: OPTICS (White Raxine) Images Formed By Mirror	1
55	LKCPH011	CPH011 Educational Raxine Charts (Size 75x100cm); PHYSICS: OPTICS (White Raxine) Images Formed By Lenses	1
Chemistry: Equipment			
56	LKPH 009/2	PH 009/2 BAR MAGNET Alnico Make (Superior Quality) 50x11x7mm (2")	2
57	LKPHN 65	PHN 65 IRON FILLING 500gm.	3
58	LKBI 010/1	BI 010/1 FORCEPS (Stainless Steel) 5" Pointed	1
59	LKBI 051/4	BI 051/4 WATCH GLASS Dia 4" (Superior Quality Per Dozen)	1
60	LKCH 009/2	CH 009/2 BUNSEN BURNER (Brass Pipe 150mm & dia.12mm) Superior with Stop Cock (Heavy Base).	6
61	LKCH 055/1	CH 055/1 RUBBER TUBING PRESSURE TYPE (Superior Quality) Bore Dia 8mm Thickness 3mm (For Burners).	1
62	LKCH 017/3	CH 017/3 CHINA DISH (Porcelain); Dia 3".	6
63	LKCH 024/2	CH 024/2 CRUCIBLE TONG (Stainless Steel) 8"	2
64	LKCH 026/3	CH 026/3 FILTER PAPER PKT. (Doctor Watt Make) Dia 12.5cm Hand Made	3
65	LKCH 030	CH 030 FUNNEL STAND (Wooden).	2
66	LKCH 033 8	CH 033 GLASS STIRRER 8"	6
67	LKCH 042/2	CH 042/2 PESTLE & MORTAR (Porcelain) Dia 4"	5
68	LKCH 058/3	CH 058/3 SPATULA S.S. (Spoon Type) 6" Heavy Quality	5
69	LKCH 059/3	CH 059/3 SPIRIT LAMP (100ml) Brass	4
70	LKCH 062/3 g	CH 062/3 (g) TEST TUBE (Borosilicate Glass) HARD GLASS 15x125mm10ml. Pk of 100	2
71	LKCH 062/5 o	CH 062/5 (o) TEST TUBE (Borosilicate Glass) HARD GLASS 25x150mm Pk of 50	1
72	LKCH 063	CH 063 TEST TUBE BRUSH (Nylon) Superior Quality.	4
73	LKCH 064/1	CH 064/1 TEST TUBE HOLDER (Wooden Handle) Iron Chrome Plated Superior Quality	12
74	LKCH 065/1	CH 065/1 TEST TUBE STAND (Wooden) 6 Hole	2
75	LKCH 068/3	CH 068/3 TRIPOD STAND 6" (Heavy Quality)	2
76	LKCH 068/4	CH 068/4 TRIPOD STAND 8" (Heavy Quality)	6
77	LKCH 070/1	CH 070/1 WATER BATH (Copper) Dia 4"	2
78	LKCH 071/2	CH 071/2 WIRE GAUGE With Frame & Asbestos Centre	12
79	LKCH 112/1	CH 112/1 BEAKER Graduated 'B.G.' 100ml	6
80	LKCH 112/3	CH 112/3 BEAKER Graduated 'B.G.' 250ml	6
81	LKCH 112/4	CH 112/4 BEAKER Graduated 'B.G.' 500ml	6

ಸಿಎಸ್‌ಎಸ್ ನಂ. 122/124, ಎಚ್‌ಡಿಎಮ್‌ಸಿ ಸಾಂಸ್ಕೃತಿಕ ಭವನ, 1ನೇ ಮಹಡಿ, ನ್ಯೂ ಕಾಟನ್ ಮಾರ್ಕೆಟ್ ರಸ್ತೆ, ಹುಬ್ಬಳ್ಳಿ-580029

CSS No. 122/124, HDMC Samskrutika Bhavan, 1st Floor, New Cotton Market Road, Hubballi-580029

Ph: 0836-2355322, Fax: 0836-2355331, Control Room Assistance: 2213888/2213898,

Website: www.hubballidharwadsmartcity.com E-mail: smartcityhubballidharwad@gmail.com

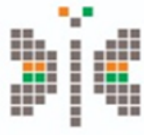

Special Purpose Vehicle for Implementation of Smart City Project
(Registered Company No. CIN : U74999KA2017 PLC 101265)

82	LKCH 112/6	CH 112/6 BEAKER Graduated 'B.G.' 50ml	6
83	LKCH 119/1	CH 119/1 FLASK CONICAL 'B.G.' 100ml	6
84	LKCH 119/2	CH 119/2 FLASK CONICAL 'B.G.' 250ml	6
85	LKCH 121/2	CH 121/2 FUNNEL 'B.G.' 75mm	8
86	LKCH 126/2 c	CH 126/2 c) MEASURING CYLINDER (Round Base) B.G Without Stopper 25ml	6
87	LKCH 126/3 d	CH 126/3 d) MEASURING CYLINDER (Round Base) B.G Without Stopper 50ml	6
88	LKCH 126/4 e	CH 126/4 e) MEASURING CYLINDER (Round Base) B.G Without Stopper 100ml	4
89	LKCH 132/2	CH 132/2 REAGENT BOTTLE (Narrow Mouth) 'B.G.' 125ml	6
90	LKCH 132/3	CH 132/3 REAGENT BOTTLE (Narrow Mouth) 'B.G.' 250ml	6
91	LKCH 136/2	CH 136/2 SEPARATING FUNNEL 'B.G.' 250ml	2
92	LKCH 139/2	CH 139/2 VOLUMETRIC FLASK (Measuring Flask) 'B.G.' 50ml	4
93	LKCH 139/3	CH 139/3 VOLUMETRIC FLASK (Measuring Flask) 'B.G.' 100ml	4
94	LKCH 139/4	CH 139/4 VOLUMETRIC FLASK (Measuring Flask) 'B.G.' 250ml	6
95	LK57202	Polylab 57202 Analytical Funnel 75 mm	2
96	LK55502	Polylab 55502 Kipps Apparatus 500 ml	1
97	LK77701	Polylab 77701 Test Tube stand 16 mm & 25 mm Ø Tubes	6
98	LK77704	Polylab 77704 Test Tube Stand (Round)- 19 mm & 25 mm Ø Tubes	2
99	LK36602	Polylab 36602 Wash Bottle 250 ml	6
100	LKCH RC/10	CH RC/10 RUBBER CORK (EXTRA SOFT) SUPERIOR QUALITY Size No. 9 Top Dia (mm) 28 Bottom Dia (mm) 21.5	3
101	LKCH RC/4	CH RC/4 RUBBER CORK (EXTRA SOFT) SUPERIOR QUALITY Size No. 3 Top Dia (mm) 19 Bottom Dia (mm) 14	10
102	LKCHN 05	CHN 05 BEAKER TONG 12" (Stainless Steel)	2
103	LKCHN 28	CHN 28 FLASK TONG 12" S.S	2
104	LKCHN 33 L	CHN 33 Delivery Tube L	4
105	LKCHN 33 U	CHN 33 Delivery Tube U	2
106	LKPH 007/1	PH 007/1 BALANCE DIGITAL Cap. 2kg L.C. 0.1gm (100mg).	1
107	LKPH 055/6	PH 055/6 CORK BORER Set of 6 (HEAVY Pattern) German Type (Export Quality) Strong Handles.	1
108	LKPH 112/2	PH 112/2 IRON STAND (with Clamp & Boss Head) 7x5" Sheet Metal (RETORT STAND) Superior Quality with Dipress Clamp & Bosshead	4
109	LKPH 250/1	PH 250/1 THERMOMETER (30cm Length) -10 to 110C Mercury.	4
110	LKPI 006/1	PI 006/1 DROPPER Plastic (3ml) Graduated.	12
111	LKPI 006/2 A	PI 006/2 (A) DROPPER GLASS WITH TEAT RUBBER TEAT 6"	12
112	LKCT	COTTON THREAD (Roll).	3
113	LKCH 041/5	CH 041/5 PERIODIC TABLE CHART Modern Periodic Table 75 x 100cm Raxine.	1
114	LKCCH002	CCH002 Educational Raxine Charts (Size 75x100cm);	1

ಸಿಎಸ್‌ಎಸ್ ನಂ. 122/124, ಎಚ್‌ಡಿಎಮ್‌ಸಿ ಸಾಂಸ್ಕೃತಿಕ ಭವನ, 1ನೇ ಮಹಡಿ, ನ್ಯೂ ಕಾಟನ್ ಮಾರ್ಕೆಟ್ ರಸ್ತೆ, ಹುಬ್ಬಳ್ಳಿ-580029

CSS No. 122/124, HDMC Samskrutika Bhavan, 1st Floor, New Cotton Market Road, Hubballi-580029

Ph: 0836-2355322, Fax: 0836-2355331, Control Room Assistance: 2213888/2213898,

Website: www.hubballidharwadsmartcity.com E-mail: smartcityhubballidharwad@gmail.com

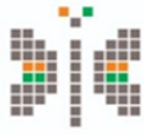

Special Purpose Vehicle for Implementation of Smart City Project
(Registered Company No. CIN : U74999KA2017 PLC 101265)

		CHEMISTRY: GENERAL (White Raxine) Laboratory Safety Measures	
Chemistry: Chemicals			
115	LKL40851	L40851 Litmus blue indicator paper 100 ls	2
116	LKL40951	L40951 Litmus red indicator paper 100 ls	2
117	LKI41056	I41056 Indicator paper pH 1-14 (Full range) 200 ls	1
118	LKD20079	D20079 D.M. Water (Deionised water) 500 ml	1
119	LKH11229 (Pack)	H11229 Hydrochloric acid (Thermocole pack) - 35% (Pack of 4x500 ml) (For Safety purpose pack is provided)	1
120	LKS15130 (Pack)	S15130 Sulphuric acid (Thermocole pack)-97 % (Pack of 4x500 ml) (For Safety purpose pack is provided)	1
121	LKCH 038	CH 038 MAGNESIUM RIBBON, 25Gm	2
122	LKE30109	E30109 Egg albumin flakes (Protein - 95%) 25 gm	1
123	LKC10017	C10017 Copper metal turnings - 99% 100 gm	1
124	LKA11025	A11025 Aluminum metal powder (Atomised) - 99.5% 250 gm	1
125	LKZ70425	Z70425 Zinc metal granulated A.R. - 99.9% (Confirms to ACS specification) 250 gm	1
126	LKA11329	A11329 Potassium alum - 99% (Aluminum Potassium sulphate) 500 gm	1
127	LKA11429	A11429 Aluminum sulphate - 98% 500 gm	1
128	LKA11929	A11929 Ammonium chloride - 99% 500 gm	1
129	LKB10329	B10329 Barium chloride - 99% 500 gm	1
130	LKC10729	C10729 Calcium chloride fused - 90% 500 gm	1
131	LKC11029	C11029 Calcium oxide powder - 98% 500 gm	1
132	LKC11529	C11529 Calcium hydroxide - 95% 500 gm	1
133	LKC12929	C12929 Cupric sulphate (Copper sulphate)-98.5% 500 gm	1
134	LKF10729	F10729 Ferrous sulphate - 98% 500 gm	1
135	LKS11929	S11929 Sodium bicarbonate - 99% (Sodiumhydrogen carbonate) 500 gm	1
136	LKS12029	S12029 Sodium carbonate anhydrous - 99.5% 500 gm	1
137	LKS12829	S12829 Sodium hydroxide flakes - 96% 500 gm	1
138	LKS13829	S13829 Sodium sulphate anhydrous - 99% 500 gm	1
139	LKS14329	S14329 Starch soluble 500 gm	1
140	LKS14529	S14529 Sulphur powder - 99.5% 500 gm	1
141	LKZ10729	Z10729 Zinc sulphate - 99% 500 gm	1
142	LKF10833	F10833 Ferrous sulphide sticks (FeS - 75%) 1 kg	1
143	LKL41171	L41171 Litmus blue solution 125 ml	1
144	LKL41181	L41181 Litmus red solution 125 ml	1
145	LKU40171	U40171 Universal indicator solution 125 ml	1
146	LKA10129	A10129 Acetic acid glacial - 99.5% 500 ml	1
147	LKC11329	C11329 Carbon disulphide - 99% 500 ml	1
148	LKL20129	L20129 Lamposolv (For spirit lamp) 500 ml	1
Biology: Equipment			
149	LKBI 052/10A	BI 052/10A HUMAN BRAIN 4 Parts Dissectible (On Base) (Model)	1
150	LKBI 052/13	BI 052/13 HUMAN EAR Model On Base	1
151	LKBI 052/14	BI 052/14 HUMAN EYE Model on Stand	1
152	LKBI 052/16	BI 052/16 HUMAN HEART on stand (2 parts Dissectible)	1
153	LKBI 052/17A	BI 052/17A HUMAN KIDNEY on Stand (2 Parts Dissectible)	1

ಸಿಎಸ್‌ಎಸ್ ನಂ. 122/124, ಎಚ್‌ಡಿಎಮ್‌ಸಿ ಸಾಂಸ್ಕೃತಿಕ ಭವನ, 1ನೇ ಮಹಡಿ, ನ್ಯೂ ಕಾಟನ್ ಮಾರ್ಕೆಟ್ ರಸ್ತೆ, ಹುಬ್ಬಳ್ಳಿ-580029

CSS No. 122/124, HDMC Samskrutika Bhavan, 1st Floor, New Cotton Market Road, Hubballi-580029

Ph: 0836-2355322, Fax: 0836-2355331, Control Room Assistance: 2213888/2213898,

Website: www.hubballidharwadsmartcity.com E-mail: smartcityhubballidharwad@gmail.com

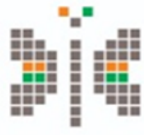

Special Purpose Vehicle for Implementation of Smart City Project
(Registered Company No. CIN : U74999KA2017 PLC 101265)

154	LKBI 052/18	BI 052/18 HUMAN LUNGS (BASIC MODEL)	1
155	LKBI 052/31	BI 052/31 LIVER MODEL	1
156	LKBI 052/46	BI 052/46 EARTHWORM DISSECTED MODEL	1
157	LKBI 013/2	BI 013/2 HUMAN SKELETON Full size (Fibre) Superior Quality	1
158	LKBI 014	BI 014 HUMAN SKELTON STAND (Metallic).	1
159	LKBI 52/12B	BI 52/12B HUMAN DIGESTIVE SYSTEM Superior Model on Board 30"x12"	1
160	LKBI 52/19B	BI 52/19B HUMAN NERVOUS SYSTEM Superior Model on Board 30"x12"	1
161	LKBI 52/20B	BI 52/20B HUMAN RESPIRATORY SYSTEM Superior Model on Board 22"x12"	1
162	LKBI 010/1	BI 010/1 FORCEPS (Stainless Steel) 5" Pointed	3
163	LKCH 028	BLOTTING PAPER,18"x22"	10
164	LKBI 051/4	BI 051/4 WATCH GLASS Dia 4" (Superior Quality Per Dozen)	1
165	LKCH 026/3	CH 026/3 FILTER PAPER PKT. (Doctor Watt Make) Dia 12.5cm Hand Made	2
166	LKCH 062/5 o	CH 062/5 (o) TEST TUBE (Borosilicate Glass) HARD GLASS 25x150mm Pk of 50	1
167	LKCH 112/3	CH 112/3 BEAKER Graduated 'B.G.' 250ml	6
168	LKCH 119/2	CH 119/2 FLASK CONICAL 'B.G.' 250ml	6
169	LKCH 126/5 f	CH 126/5 f) MEASURING CYLINDER (Round Base) B.G Without Stopper 250ml	2
170	LKCH RC/10	CH RC/10 RUBBER CORK (EXTRA SOFT) SUPERIOR QUALITY Size No. 9 Top Dia (mm) 28 Bottom Dia (mm) 21.5	2
171	LKCHN 33 L	CHN 33 Delivery Tube L	2
172	LKCT	COTTON THREAD (Roll).	1
173	LKBI 005/2	BI 005/2 COVERSLIP (Pk. of 10Gm) 18mm Round	12
174	LKBI 006/4	BI 006/4 DISSECTING TRAY with Wax Size 10"x12" Stainless Steel	1
175	LKBI 008/2A	BI 008/2 DISSECTING NEEDLE Stainless Steel Thin	4
176	LKBI 021B	BI 021B COMPOUND MICROSCOPE (STUDENT) Two eyepiece 10x 15x & two objectives 10x 40x with fixed condenser MICRON Make (KG-2) ISI Marked (Thermo Cole Box)	3
177	LKBI 029C	BI 029C MICROSCOPE LIGHT LED (Pin Type)	3
178	LK62106	Polylab 62106 Slide Box- 100 Slides	1
179	LKBI 042	BI 042 PLAIN SLIDE Size 75x25mm Glass Thickness 1.35 (Pk of 50)	5
180	LKBI 053/1 1	BI 053/1 PREPARED SLIDE FOR MICROSCOPE PLANT TISSUE:- Parenchyma	1
181	LKBI 053/1 2	BI 053/1 PREPARED SLIDE FOR MICROSCOPE PLANT TISSUE:-Collenchyma	1
182	LKBI 053/1 3	BI 053/1 PREPARED SLIDE FOR MICROSCOPE PLANT TISSUE:- Sclerenchyma	1
183	LKBI 053/1 4	BI 053/1 PREPARED SLIDE FOR MICROSCOPE PLANT TISSUE:- Xylem	1
184	LKBI 053/1 5	BI 053/1 PREPARED SLIDE FOR MICROSCOPE PLANT TISSUE:- Phloem	1
185	LKBI 053/1 6	BI 053/1 PREPARED SLIDE FOR MICROSCOPE PLANT TISSUE:- Dicot Stem	1
186	LKBI 053/1 8	BI 053/1 PREPARED SLIDE FOR MICROSCOPE PLANT TISSUE:- Dicot Root	1

ವಿವಿಧ ಸಂಖ್ಯೆಗಳಲ್ಲಿ ನಂ. 122/124, ಎಚ್‌ಡಿಎಮ್‌ಸಿ ಸಾಂಸ್ಕೃತಿಕ ಭವನ, 1ನೇ ಮಹಡಿ, ನ್ಯೂ ಕಾಟನ್ ಮಾರ್ಕೆಟ್ ರಸ್ತೆ, ಹುಬ್ಬಳ್ಳಿ-580029

CSS No. 122/124, HDMC Samskrutika Bhavan, 1st Floor, New Cotton Market Road, Hubballi-580029

Ph: 0836-2355322, Fax: 0836-2355331, Control Room Assistance: 2213888/2213898,

Website: www.hubballidharwadsmartcity.com E-mail: smartcityhubballidharwad@gmail.com

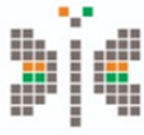

Special Purpose Vehicle for Implementation of Smart City Project
(Registered Company No. CIN : U74999KA2017 PLC 101265)

187	LKBI 053/1 9	BI 053/1 PREPARED SLIDE FOR MICROSCOPE PLANT TISSUE:- Monocot Root	1
188	LKBI 053/1 10	BI 053/1 PREPARED SLIDE FOR MICROSCOPE PLANT TISSUE:- Dicot Leaf	1
189	LKBI 053/1 11	BI 053/1 PREPARED SLIDE FOR MICROSCOPE PLANT TISSUE:- Monocot Leaf	1
190	LKBI 053/1 18	BI 053/1 PREPARED SLIDE FOR MICROSCOPE PLANT TISSUE:- Chlorella	1
191	LKBI 053/1 20	BI 053/1 PREPARED SLIDE FOR MICROSCOPE PLANT TISSUE:- Spirogyra	1
192	LKBI 053/1 21	BI 053/1 PREPARED SLIDE FOR MICROSCOPE PLANT TISSUE:- Volvox	1
193	LKBI 053/1 22	BI 053/1 PREPARED SLIDE FOR MICROSCOPE PLANT TISSUE:- Nostoc	1
194	LKBI 053/1 23	BI 053/1 PREPARED SLIDE FOR MICROSCOPE PLANT TISSUE:- Yeast	1
195	LKBI 053/1 24	BI 053/1 PREPARED SLIDE FOR MICROSCOPE PLANT TISSUE:- Lichen	1
196	LKBI 053/1 25	BI 053/1 PREPARED SLIDE FOR MICROSCOPE PLANT TISSUE:- Oscillatoria	1
197	LKBI 053/1 26	BI 053/1 PREPARED SLIDE FOR MICROSCOPE PLANT TISSUE:- Rhizopus	1
198	LKBI 053/1 30	BI 053/1 PREPARED SLIDE FOR MICROSCOPE PLANT TISSUE:- Pinus Cone Male	1
199	LKBI 053/1 31	BI 053/1 PREPARED SLIDE FOR MICROSCOPE PLANT TISSUE:- Pinus Cone Female	1
200	LKBI 053/2 2	BI 053/2 PREPARED SLIDE FOR MICROSCOPE ANIMAL TISSUE:- Squamous Epithelium	1
201	LKBI 053/2 3	BI 053/2 PREPARED SLIDE FOR MICROSCOPE ANIMAL TISSUE:- Cuboidal Epithelium	1
202	LKBI 053/2 4	BI 053/2 PREPARED SLIDE FOR MICROSCOPE ANIMAL TISSUE:- Columnar Epithelium	1
203	LKBI 053/2 5	BI 053/2 PREPARED SLIDE FOR MICROSCOPE ANIMAL TISSUE:- Nerve Cell	1
204	LKBI 053/2 6	BI 053/2 PREPARED SLIDE FOR MICROSCOPE ANIMAL TISSUE:- Muscle: Cardiac	1
205	LKBI 053/2 7	BI 053/2 PREPARED SLIDE FOR MICROSCOPE ANIMAL TISSUE:- Muscle: Striated	1
206	LKBI 053/2 8	BI 053/2 PREPARED SLIDE FOR MICROSCOPE ANIMAL TISSUE:- Muscle: Unstrained	1
207	LKBI 053/2 9	BI 053/2 PREPARED SLIDE FOR MICROSCOPE ANIMAL TISSUE:- Muscle: Smooth Muscle	1
208	LKBI 053/2 11	BI 053/2 PREPARED SLIDE FOR MICROSCOPE ANIMAL TISSUE:- Mammal: Heart	1
209	LKBI 053/2 12	BI 053/2 PREPARED SLIDE FOR MICROSCOPE ANIMAL TISSUE:- Mammal: Ovary	1
210	LKBI 053/2 13	BI 053/2 PREPARED SLIDE FOR MICROSCOPE ANIMAL TISSUE:- Mammal: Testis	1
211	LKBI 053/2 14	BI 053/2 PREPARED SLIDE FOR MICROSCOPE ANIMAL TISSUE:- Mammal: Skin	1
212	LKBI 053/2 15	BI 053/2 PREPARED SLIDE FOR MICROSCOPE ANIMAL TISSUE:- Mammal: Bone	1
213	LKBI 053/2 16	BI 053/2 PREPARED SLIDE FOR MICROSCOPE ANIMAL TISSUE:- Mammal: Artery	1
214	LKBI 053/2 17	BI 053/2 PREPARED SLIDE FOR MICROSCOPE	1

ವಿವಿಧ ನಂ. 122/124, ಎಚ್‌ಡಿಎಮ್‌ಸಿ ಸಾಂಸ್ಕೃತಿಕ ಭವನ, 1ನೇ ಮಹಡಿ, ನ್ಯೂ ಕಾಟನ್ ಮಾರ್ಕೆಟ್ ರಸ್ತೆ, ಹುಬ್ಬಳ್ಳಿ-580029

CSS No. 122/124, HDMC Samskrutika Bhavan, 1st Floor, New Cotton Market Road, Hubballi-580029

Ph: 0836-2355322, Fax: 0836-2355331, Control Room Assistance: 2213888/2213898,

Website: www.hubballidharwadsmartcity.com E-mail: smartcityhubballidharwad@gmail.com

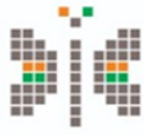

Special Purpose Vehicle for Implementation of Smart City Project
(Registered Company No. CIN : U74999KA2017 PLC 101265)

		ANIMAL TISSUE:- Mammal: Vein	
215	LKBI 053/2 18	BI 053/2 PREPARED SLIDE FOR MICROSCOPE ANIMAL TISSUE:- Mammal: Liver	1
216	LKBI 053/2 21	BI 053/2 PREPARED SLIDE FOR MICROSCOPE ANIMAL TISSUE:- Mammal: Stomach	1
217	LKBI 053/2 23	BI 053/2 PREPARED SLIDE FOR MICROSCOPE ANIMAL TISSUE:- Mammal: Blood	1
218	LKBI 053/2 28	BI 053/2 PREPARED SLIDE FOR MICROSCOPE ANIMAL TISSUE:- Bacteria	1
219	LKBI 053/2 29	BI 053/2 PREPARED SLIDE FOR MICROSCOPE ANIMAL TISSUE:- Paramecium	1
220	LKBI 053/4 1	BI 053/4 PREPARED SLIDE FOR MICROSCOPE Slide Amoeba	1
221	LKBI 053/6 1	BI 053/6 PREPARED SLIDE FOR MICROSCOPE Slide Hydra	1
222	LKBI 053/6 2	BI 053/6 PREPARED SLIDE FOR MICROSCOPE Slide Yeast Budding	1
223	LKBI 053/7	BI 053/7 PREPARED SLIDE FOR MICROSCOPE Slide Mitosis Set of 5 slides onion	1
224	LKBI 053/8	BI 053/8 PREPARED SLIDE FOR MICROSCOPE Slide Meiosis Set of 12 slides onion	1
225	LKBI 053/9	BI 053/9 PREPARED SLIDE FOR MICROSCOPE Binary Fission Amoeba	1
226	LKBI 055/A 1	BI 055/A SPECIMEN IN PLASTIC JAR ZOOLOGY SPECIMENS (Common) Sponge	1
227	LKBI 055/A 3	BI 055/A SPECIMEN IN PLASTIC JAR ZOOLOGY SPECIMENS (Common) Liver Fluke	1
228	LKBI 055/A 5	BI 055/A SPECIMEN IN PLASTIC JAR ZOOLOGY SPECIMENS (Common) Earthworm	1
229	LKBI 055/A 9	BI 055/A SPECIMEN IN PLASTIC JAR ZOOLOGY SPECIMENS (Common) Hydra	1
230	LKBI 055/A 13	BI 055/A SPECIMEN IN PLASTIC JAR ZOOLOGY SPECIMENS (Common) Cockroach	1
231	LKBI 055/A 14	BI 055/A SPECIMEN IN PLASTIC JAR ZOOLOGY SPECIMENS (Common) Grasshopper	1
232	LKBI 055/A 24	BI 055/A SPECIMEN IN PLASTIC JAR ZOOLOGY SPECIMENS (Common) Bony Fish	1
233	LKBI 055/C 9	BI 055/C SPECIMEN IN PLASTIC JAR ZOOLOGY SPECIMENS (Special) Labeorohita	1
234	LKBI 055/C 10	BI 055/C SPECIMEN IN PLASTIC JAR ZOOLOGY SPECIMENS (Special) Catfish	1
235	LKBI 055/C 19	BI 055/C SPECIMEN IN PLASTIC JAR ZOOLOGY SPECIMENS (Special) Leech	1
236	LKBI 055/B 1	BI 055/B SPECIMEN IN PLASTIC JAR BOTANY SPECIMENS (Common) Spirogyra	1
237	LKBI 055/B 3	BI 055/B SPECIMEN IN PLASTIC JAR BOTANY SPECIMENS (Common) Funaria	1
238	LKBI 055/B 4	BI 055/B SPECIMEN IN PLASTIC JAR BOTANY SPECIMENS (Common) Marchantia	1
239	LKBI 055/B 5	BI 055/B SPECIMEN IN PLASTIC JAR BOTANY SPECIMENS (Common) Riccia	1
240	LKBI 055/B 6	BI 055/B SPECIMEN IN PLASTIC JAR BOTANY SPECIMENS (Common) Agaricus	1
241	LKBI 055/B 12	BI 055/B SPECIMEN IN PLASTIC JAR BOTANY SPECIMENS (Common) Sunflower	1

ವಿವಿಎಸ್ ನಂ. 122/124, ಎಚ್‌ಡಿಎಮ್‌ಸಿ ಸಾಂಸ್ಕೃತಿಕ ಭವನ, 1ನೇ ಮಹಡಿ, ನ್ಯೂ ಕಾಟನ್ ಮಾರ್ಕೆಟ್ ರಸ್ತೆ, ಹುಬ್ಬಳ್ಳಿ-580029

CSS No. 122/124, HDMC Samskrutika Bhavan, 1st Floor, New Cotton Market Road, Hubballi-580029

Ph: 0836-2355322, Fax: 0836-2355331, Control Room Assistance: 2213888/2213898,

Website: www.hubballidharwadsmartcity.com E-mail: smartcityhubballidharwad@gmail.com



Special Purpose Vehicle for Implementation of Smart City Project
(Registered Company No. CIN : U74999KA2017 PLC 101265)

242	LKBI 055/B 27	BI 055/B SPECIMEN IN PLASTIC JAR BOTANY SPECIMENS (Common) Lichen	1
243	LKBI 055/B 28	BI 055/B SPECIMEN IN PLASTIC JAR BOTANY SPECIMENS (Common) Pinus Male Cone	1
244	LKBI 055/B 30	BI 055/B SPECIMEN IN PLASTIC JAR BOTANY SPECIMENS (Common) Pinus Female Cone	1
245	LKBI 055/D 4	BI 055/D SPECIMEN IN PLASTIC JAR BOTANY SPECIMENS (Special) Fern (Dryopteris)	1
246	LKBI 109	BI 109 FINE POINTED BRUSH (Camel Type) No.0.	12
247	LKBIN 06/2	BIN 06/2 DISSECTING BOARD (Wooden) 12"X 18"	1
248	LKCH 129/2	CH 129/2 PETRI DISH IMPORTED (Anumbra) Crystal Clear Glass 4"	4
249	LKCZ154	CZ154 Educational Raxine Charts (Size 75x100cm); ZOOLOGY: AVES (Black Raxine) Pigeon External & Internal Characters	1
250	LKCZ058	CZ058 Educational Raxine Charts (Size 75x100cm); ZOOLOGY: ARTHROPODA (Black Raxine) Cockroach Anatomy	1
251	LKCBO081	CBO081 Educational Raxine Charts (Size 75x100cm); BOTANY: ANGIOSPERMS (Black Raxine) Comparison of Monocot & Dicot Plants	1
Biology: Chemicals			
252	LKD20079	D20079 D.M. Water (Deionized water) 500 ml	1
253	LKF11229	F11229 Formaldehyde solution (37 - 41% w/v) (Formalin) 500 ml	1
254	LKS13325	S13325 Sodium metal - 99% (in liquid paraffin) 250 gm	1
255	LKL10129	L10129 Lead acetate - 99% 500 gm	1
256	LKL30329	L30329 Lead nitrate - 99% 500 gm	1
257	LKP12129	P12129 Potassium dichromate - 99.5% 500 gm	1
258	LKP12429	P12429 Potassium hydroxide flakes - 85% 500 gm	1
259	LKM31971	M31971 Methylene blue aqueous 1% w/v 125 ml	1
260	LKS30271	S30271 Safranin stain solution 125 ml	1
261	LKG11029	G11029 Glycerine (Glycerol) - 98% 500 ml	1
262	LKH10729	H10729 Hydrogen peroxide 100 vol. (30% w/v) 500 ml	1
263	LKM12029	M12029 Methanol (Methyl alcohol) Acetone free (suitable for stains & indicators) - 99% 500 ml	1

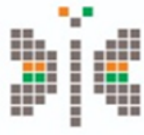

Special Purpose Vehicle for Implementation of Smart City Project
(Registered Company No. CIN : U74999KA2017 PLC 101265)

Annexure D: Mathematics Lab specification

Sl. no	Product Description	Tech Description	Quantity
1	Colour solid Set (438A)	STMLB 438 A 3D Colour Solid Set 10CM, Size: 10CM Set of 12Pcs, with Lid	1
2	Fractions Wheel Magnetic with Printing (907)	STMLB 907 Fractions Wheel Magnetic with Printing	1
3	Fraction Square -902	STMLB 902 Fraction Square	1
4	Tangram Plastic -709	STMLB 709 Tangram Plastic	1
5	Pattern Making Triangle (702)	STMLB 702 Pattern Making Triangle	1
6	Decimal Kit -601	LKNB 601 Decimal Kit	1
7	Geo Geometry Sticks (423)	STMLB 423 Geo Geometry Stick (set of 24 pcs)	1
8	Circular Geo Board (421)	STMLB 421 Circular Geoboard	1
9	Isometric Geo Board (420)	STMLB Isometric Geoboard	1
10	Place Value Mat with Sticking Counters (304)	STMLB 304 Place Value Mat with Sticking Counter	1
11	(A+B+C) ² (STMLB 6000)	STMLB 6000 Case 1 (a+b+c) ²	1
12	(A+B) ² -(A- B) ² =4AB (STMLB6001)	STMLB 6001 Case 2 (a+b) ² -(a-b) ² =4ab	1
13	(A+B) ³ (STMLB 6002)	STMLB 6002 Cubic identity (a+b) ³	1
14	Algebra Kit -6003	STMLB 6003 Algebra Kit	1
15	Pythagoras Theorem (STMLB 5000/5001)	STMLB 5000 Junior Pythagoras Theorem	1
16	NIL	STMLB 5000 Senior Pythagoras Theorem (Magnetic)	1
17	Circle Kit (STMLB 1002)	STMLB 1000 Circle Kit	1

ವಿವಿಧ ನಂ. 122/124, ಎಚ್‌ಡಿಎಮ್‌ಸಿ ಸಾಂಸ್ಕೃತಿಕ ಭವನ, 1ನೇ ಮಹಡಿ, ನ್ಯೂ ಕಾಟನ್ ಮಾರ್ಕೆಟ್ ರಸ್ತೆ, ಹುಬ್ಬಳ್ಳಿ-580029

CSS No. 122/124, HDMC Samskrutika Bhavan, 1st Floor, New Cotton Market Road, Hubballi-580029

Ph: 0836-2355322, Fax: 0836-2355331, Control Room Assistance: 2213888/2213898,

Website: www.hubballidharwadsmartcity.com E-mail: smartcityhubballidharwad@gmail.com



Special Purpose Vehicle for Implementation of Smart City Project
(Registered Company No. CIN : U74999KA2017 PLC 101265)

18	Symmetry Kit (STMLB708)	STMLB 708 Symmetry Kit	1
19	Area of Circle (STMLB446)	STMLB 446 Area of Circle - Same as derivation of Pie	1
20	Parallelogram Kit (STMLB 444)	STMLB 444 Parallelogram Kit	1
21	Perpendicular Line Segment is Shortest Path (443)	STMLB 443 Perpendicular Line Segment is the Shortest)	1
22	Tangent Geo Board (440)	STMLB 440 Tangent Geoboard	1
23	Angle Sum Property of Quadrilateral(-435)	STMLB 435 Angle Sum Property of Quadrilateral	1
24	Angle Sum Property of Triangle (433)	STMLB 433 Angle Sum Property Of Triangle	1
25	Angle Sum Property of Cyclic Quadrilateral	STMLB 432 Cyclic Quadrilateral	1
6	Exterior Angle Of Regular Polygon (432)	STMLB 430 Exterior Angle of Regular Polygon	1
27	Geometry Kit (424)	STMLB 424 Geometry Kit (set of 7 sticks)	1
28	X-Y axis Co- ordinate Geo Board	STMLB 417 XY axes Co- ordinate Geoboard	1
29	Volume Relation between Cone and Cylinder	STMLB 415 Volume Relation Between Cone & Cylinder	1
30	Trigonometry (7003)	STMLB 7003 Trigonometry Board	1
31	Trigonometry Puzzle Type- 1(7004)	STMLB 7004 Trigonometry Puzzle Type-1	1
32	Trigonometry Puzzle-Type- 2 (7005)	STMLB 7005 Trigonometry Puzzle Type -2	1
33	Arithmetic Progression Kit - (LK4504)	STMLB 04 Arithmetic Progression Kit	1
34	Composite Math's Wooden Lab Table Dimension: 2.5X6 ft 3.5 Ft Height		4